

OEM Automatic AB

Postadress: Box 1011, 573 28 Tranås

Besöksadress: Dalagatan 4, 573 28 Tranås

075-242 42 00 | kundsupport@oemautomatic.se | www.oemautomatic.se

Industrilås
When access counts

KOMPLETT 90°-LÅS, 12 MM, KONFIGURERBART

KOMPLETT 90°-LÅS, 12 MM, KONFIGURERBART

Du designar denna vibrationsresistenta kvartsvarvslåset för att tillgodose dina behov genom att kombinera dina val av hus, mutter, insats, bricka, skruv och kam. Spärren kan levereras omonterad, förmonterad med medföljande kam eller helt monterad. Låset klickar till öppna och stängda positioner med bra taktill feedback. Vibrationsbeständig enligt DIN EN 61373. Finns med IP65 -skydd och vattentät enligt NEMA 4.



- 12 mm låshus
- Vibrationsresistent
- Upp till täthetsklass IP65
- Kompakt

PRODUKTBESKRIVNING

Låshus för vibrationsresistent 90°-lås.

Denna variant är uppbyggd med produktnyckel, vilket löses tillsammans med produktansvarig.

Låshus : Zinc , svart pulverlack.

Montering: Gaffelfjäder

Låshus variant: fyrkant med storlek 8

Ytbeläggning: chrome

Regel: stål

H/L mått: 00/45 mm

Montaget med gaffelfjäder sparar tid vid montering och håller låset säkert på plats. Avsett för plåttjocklek upp till 2,7 mm.

O-ring på insatsen och en planpackning på låshuset tätar låset.

MATERIAL:

Låshus: Zink, förkromad eller svart pulverlack, struktur.

Insats: Zink, förkromad eller svart pulverlack, struktur.

Regel och skruv: Stål, fzb.



















Bricka: Rostfritt stål (304).







Gaffelfjäder: Fjäderstål SS 1774-04, fzb.

Ett beställningsnummer består av: AAAA-BCCDEF-GGGG.

Byt ut bokstäverna mot siffrorna som motsvarar beställningsnumret.

AAAA-	Låshus	B	Mutter	CC	Insats	Bild	D	Ytbh.	E	Montering	F	Regel	-GGGG	H/L-mått i mm
2402-	Zink, krom A=28 B=4	0	SM	01	Fyrkant 6		2	Krom		IP54, omonterat	0	Stål	-0000	--

2406-	Zink, svart A=28 B=4	1	JM	03	Fyrkant 7		6	Svart	1	IP65, monterat	-0245	2/45
2430-	Zink, plastkrage, A=28 B=4			05	Fyrkant 8				2	IP54, bipackad regel	-0645	6/45
				07	Fyrkant 8 mejselspår				3	IP65, bipackad regel	-0845	8/45
				08	Fyrkant 8 / M6				4	IP54, monterat	-1045	10/45
				11	Fyrkant 8 försänkt				5	IP65, monterat	-1245	12/45
				14	Trekant 7						-1445	14/45
				15	Trekant 8						-1645	16/45
				16	Trekant 10						-1845	18/45
				17	Trekant 10 / M5						-2045	20/45
				18	Trekant 10 / M6						-2245	22/45
				19	Trekant 10 / SEN						-2445	24/45
				21	Trekant 10 Radie						-2645	26/45
				22	DIN 3						-2845	28/45
				24	DIN 5						-3045	30/45
				26	Mejselspår						-3245	32/45
				28	Mejselspår med pil						-3445	34/45
				29	Försänkt mejselspår						-3645	36/45
				31	Sexkant 8,5						-3845	38/45

32	Sexkant 11		-4045	40/45
34	Insex 8		-4245	42/45
35	Insex 10		-4445	44/45
36	Insex 8 / 3 mm stift			
37	Massiv insats			
39	Trekant 10 - radie			

TEKNISK DATA

Konfigurerbar

Ja

Öppningsvinkel

90 °

AAAA	Låskod	B	Pluttar	SS	Insats	D	Yttre	E	Montering	F	Regel	GGGG	H/H
22 mm (AAAA-BCCCCF-GGGG)													
2422	Zink, Brickskad	3	50		Pluttar 6	2	Krom	1	2754, innerskiva	15	50	-3200	80mm regel
2424	Zink, svart	3	50		Pluttar 7	3	B svart	1	2762, innerskiva	15	50	-3245	2x45
3420	Zink med zinkbeleg	3	50		Pluttar 6	3		1	2754, innerskiva regel	15	50	-3640	6x45
					Pluttar 6	3		1	2762, innerskiva regel	15	50	-3840	6x45
					Pluttar 6 / 16	4		1	2754, innerskiva	15	50	-1245	12x45
					Pluttar 6 / 30radie	3		1	2762, innerskiva	15	50	-1245	12x45
					Pluttar 7	3		1	2762, innerskiva	15	50	-1445	14x45
					Pluttar 8	3		1	2762, innerskiva	15	50	-1445	14x45
					Pluttar 10	3		1	2762, innerskiva	15	50	-1645	16x45
					Pluttar 12 / 16	3		1	2762, innerskiva	15	50	-2045	20x45
					Pluttar 12 / 30	3		1	2762, innerskiva	15	50	-2245	22x45
					Pluttar 18 radie	3		1	2762, innerskiva	15	50	-2645	26x45
					Pluttar 3	3		1	2762, innerskiva	15	50	-2845	28x45
					Pluttar 5	3		1	2762, innerskiva	15	50	-3045	30x45
					Pluttar 6	3		1	2762, innerskiva	15	50	-3245	32x45
					Pluttar 8 med 20	3		1	2762, innerskiva	15	50	-3445	34x45
					Pluttar 8 med 30	3		1	2762, innerskiva	15	50	-3640	36x45
					Pluttar 8,5	3		1	2762, innerskiva	15	50	-3840	38x45
					Pluttar 11	3		1	2762, innerskiva	15	50	-4045	40x45
					Pluttar 8	3		1	2762, innerskiva	15	50	-4245	42x45
					Pluttar 10	3		1	2762, innerskiva	15	50	-4445	44x45
					Pluttar 12 med 16	3		1	2762, innerskiva	15	50	-4645	46x45
					Pluttar 12 med 30	3		1	2762, innerskiva	15	50	-4845	48x45

 COMBI

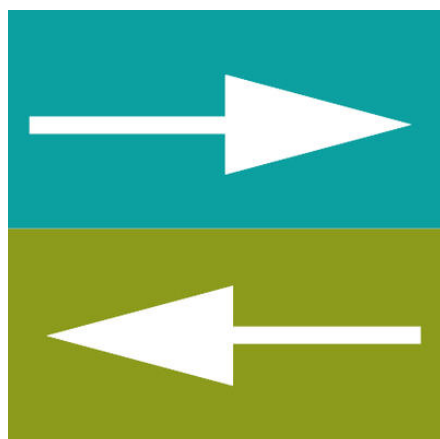
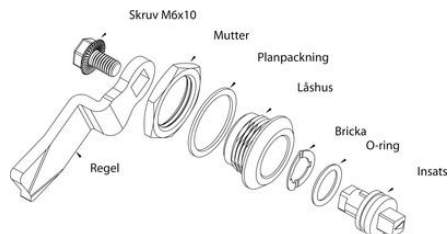
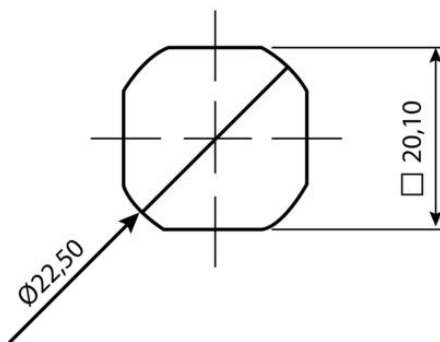

IP65

