

PR ONE KAMSTRÖMSTÄLLARE 16 A (AC21)

227600

PR ONE 16 A omkopplare "0-1" 1-pol A8

- Prisvärd
- 16 A (AC21)
- Komplet med vred och skylt
- Skruvmontage
- Standardfunktioner



PRODUKTBESKRIVNING

BACO PR ONE är en ny serie prisvärda kamströmställare som utvecklats med fokus på standardfunktioner. Produktserien finns med de vanligaste standardfunktionerna i märkströmmarna 16 A, 25 A och 32 A (AC21).



Design och funktion

- | | |
|---|---|
| • Tvångsöppnande kontakter | • Brytkapacitet Ie (A): 16 A, 25 A, 32 A vid AC21 |
| • Beröringsskyddade kontakter (IP20) | • Frontskylt: plastlaminat i aluminium med svart text |
| • Kortslutningsskyddad | • Lasermärkta anslutningar på brytarhuset |
| • Isolationsskyddad U_i <math>< 690 V</math> | • Kapslingsklass IP40 i front |
| • Levereras med öppna skruvanslutningar | • Panelmontage med två skruv i front (CC=30 mm) |

Varje kamströmställare levereras komplett med vred och graverad skylt, vilket gör det enkelt att beställa.

PR ONE är anpassade för panelmontage med skruv.

PR ONE passar speciellt bra vid stora volymer och där man använder sig av standardfunktioner.

För att komma till vår PREMIUMSERIE PR12-PR160 klicka [HÄR](#).

Vad är det som skiljer PR ONE och vår PREMIUMSERIE PR12-PR160?

I stora drag är det följande skillnader mellan produkterna:

PR ONE	PREMIUMSERIE PR12-PR160
• Plastaxel	• Metallaxel
• Standardfunktioner	• Kundenpassningsbar
• 33 artikelnummer	• "Obegränsat" med funktioner (>60 000 funktionsscheman hos BACO)
• Panelmontage med skruv	• En mängd olika monteringsmöjligheter (Ex. skruv, DIN-skena, enhålsmontage, NORM, bottenmontage m.m.)
• Märkström 16-32 A	• Märkström 10-250 A (inkl. minikamströmställaren 10 A)
• Svart vred	• Många olika handtag och nyckelvred

Skyltarna WE40 samt rubrikskylt IF9 med hållare Q040 passar till PR ONE, om man har önskemål om att köpa till rubrikskylt eller en annan positionstext för PR ONE.

TEKNISKA DATA

Tekniska data



Termisk märkström (A)	Ith	20	32	40
Märkbrytström (A)	AC21	16	25	32
Märkbrytström (A)	AC15	6	10	12
Märkeffekt AC-3 (kW)	3x230 V	3	4	5,5
	3x400 V	4	7,5	11
Märkeffekt AC-23 (kW)	3x230 V	4	7,5	11
	3x400 V	7,5	11	11
Isolationsmärkspänning, Ui (V)		690	690	690
Märkkorttidsström (A)	Icw, 1 sek.	300	300	300
Max. kabelarea mm²	Enkelledare	4	6	6
	Flertrådig	2,5	4	6
Mekanisk livslängd, antal operationer (max. 150 operationer per tim.)		800 000	800 000	800 000
Drifttemperatur		-20 till +70 °C		
Kapslingsklass	Front	IP40	IP40	IP40
	Bak	IP20	IP20	IP20
Godkännanden		 IEC EN 60947-1, 60947-3 UL508		

MÅTT

PR ONE 16 A (ie)

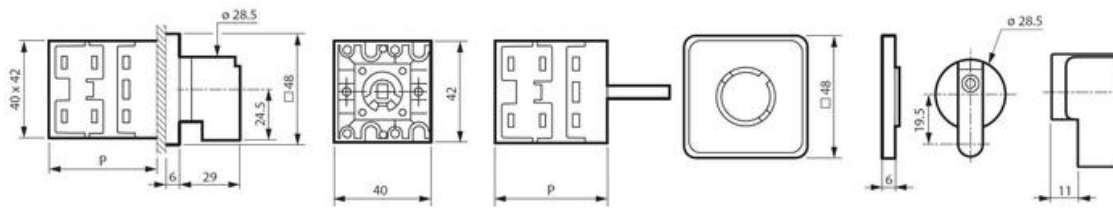

Mått i mm

- P = 36 (1-2 kontakter)
- P = 46 (3-4 kontakter)
- P = 56 (5-6 kontakter)

PR ONE 25 A (ie)

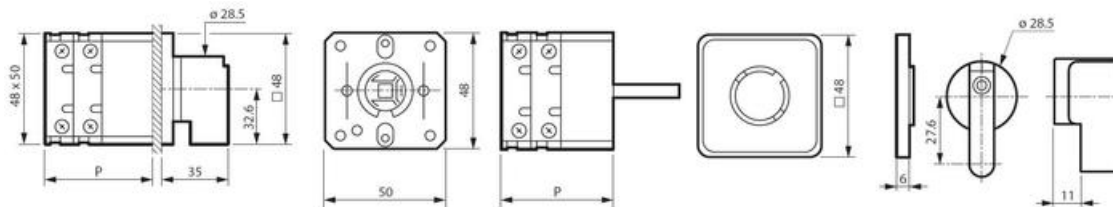

Mått i mm

- P = 33 (1-2 kontakter)
- P = 45 (3-4 kontakter)
- P = 57 (5-6 kontakter)

PR ONE 32 A (ie)

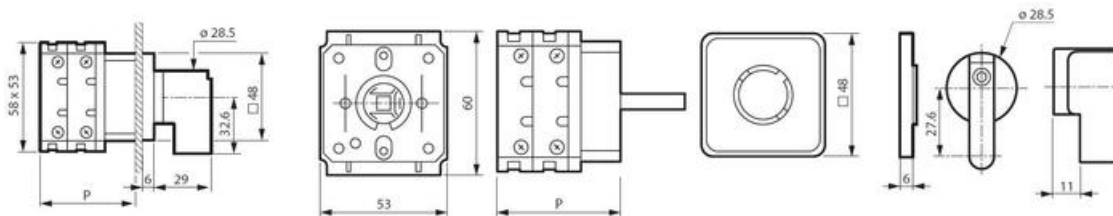

Mått i mm

- P = 36 (1-2 kontakter)
- P = 51 (3-4 kontakter)
- P = 66 (5-6 kontakter)

Håltagning i panel (16A, 25A, 32A)

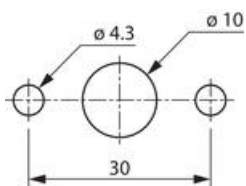

Beställningsnummer

Omkopplare AV/PA

1-, 2- och 3-poliga omkopplare



Kontaktfunktion
(x = kontakt sluten)

No. of contacts	0	1	
1-2		X	1P
3-4		X	2P
5-6		X	3P

Anslutningar/
byglingar

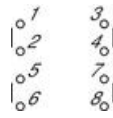

Märkström
(AC21)

Poler/kontakter

Skylt

Best.nr.

16 A	1-polig / 1 kontakt		227600
	2-polig / 2 kontakter		227601
	3-polig / 3 kontakter		227602

25 A	1-polig / 1 kontakt		227603
	2-polig / 2 kontakter		227604
	3-polig / 3 kontakter		227605

32 A	1-polig / 1 kontakt		227606
	3-polig / 3 kontakter		227608

Omkopplare med 0-läge

1-, 2- och 3-poliga omkopplare



Kontaktfunktion
(x = kontakt sluten)

No. of contacts	1	0	2	
1-2	X			1P
3-4	X		X	2P
5-6	X		X	2P
7-8			X	2P
9-10	X			3P
11-12	X		X	3P

Anslutningar/
byglingar

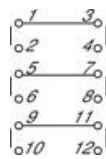

Märkström
(AC21)

Poler/kontakter

Skylt

Best.nr.

16 A	1-polig / 2 kontakter		227609
	2-polig / 4 kontakter		227610
	3-polig / 6 kontakter		227611

25 A	1-polig / 2 kontakter		227612
	2-polig / 4 kontakter		227613
	3-polig / 6 kontakter		227614

32 A	1-polig / 2 kontakter		227615
	2-polig / 4 kontakter		227616
	3-polig / 6 kontakter		227617

Omkopplare 2-vägs med 0-läge

1-, 2- och 3-poliga omkopplare



Kontaktfunktion
(x = kontakt sluten)

No. of contacts	0	1	2	
1-2		X		1P
3-4		X	X	1P
5-6		X	X	2P
7-8		X	X	2P
9-10		X	X	3P
11-12		X	X	3P

Anslutningar/
byglingar

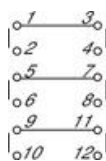

Märkström
(AC21)

Poler/kontakter

Skylt

Best.nr.

16 A	1-polig / 2 kontakter		227618
	2-polig / 4 kontakter		227619
	3-polig / 6 kontakter		227620

25 A	1-polig / 2 kontakter		227624
------	-----------------------	--	--------

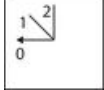
2-polig / 4 kontakter		227625
3-polig / 6 kontakter		227626

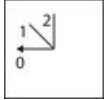
32 A	1-polig / 2 kontakter		227630
	2-polig / 4 kontakter		227631
	3-polig / 6 kontakter		227632

Omkopplare 3-vägs med 0-läge

1-poliga omkopplare

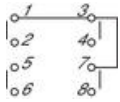
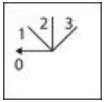
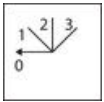

Kontaktfunktion (x = kontakt sluten)	Anslutningar/ byglingar	Märkström (AC21)	Poler/kontakter	Skylt	Best.nr.																				
<table border="1"> <tr> <th>No. of contacts</th> <th>0</th> <th>1</th> <th>2</th> <th>3</th> </tr> <tr> <td>1-2</td> <td></td> <td>X</td> <td></td> <td></td> </tr> <tr> <td>3-4</td> <td></td> <td></td> <td>X</td> <td></td> </tr> <tr> <td>7-8</td> <td></td> <td></td> <td></td> <td>X</td> </tr> </table> 	No. of contacts	0	1	2	3	1-2		X			3-4			X		7-8				X		16 A	1-polig / 3 kontakter		227621
No. of contacts	0	1	2	3																					
1-2		X																							
3-4			X																						
7-8				X																					
		25 A	1-polig / 3 kontakter		227627																				

Omkopplare 4-vägs med 0-läge

1-poliga omkopplare

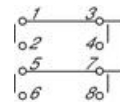
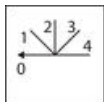

Kontaktfunktion (x = kontakt sluten)	Anslutningar/ byglingar	Märkström (AC21)	Poler/kontakter	Skylt	Best.nr.																														
<table border="1"> <tr> <th>No. of contacts</th> <th>0</th> <th>1</th> <th>2</th> <th>3</th> <th>4</th> </tr> <tr> <td>1-2</td> <td></td> <td>X</td> <td></td> <td></td> <td></td> </tr> <tr> <td>3-4</td> <td></td> <td></td> <td>X</td> <td></td> <td></td> </tr> <tr> <td>5-6</td> <td></td> <td></td> <td></td> <td>X</td> <td></td> </tr> <tr> <td>7-8</td> <td></td> <td></td> <td></td> <td></td> <td>X</td> </tr> </table> 	No. of contacts	0	1	2	3	4	1-2		X				3-4			X			5-6				X		7-8					X		16 A	1-polig / 4 kontakter		227622
No. of contacts	0	1	2	3	4																														
1-2		X																																	
3-4			X																																
5-6				X																															
7-8					X																														

Omkopplare 5-vägs med 0-läge

1-poliga omkopplare

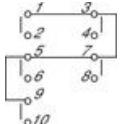
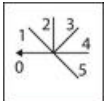
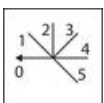

Kontaktfunktion (x = kontakt sluten)	Anslutningar/ byglingar	Märkström (AC21)	Poler/kontakter	Skylt	Best.nr.																																										
<table border="1"> <tr> <th>No. of contacts</th> <th>0</th> <th>1</th> <th>2</th> <th>3</th> <th>4</th> <th>5</th> </tr> <tr> <td>1-2</td> <td></td> <td>X</td> <td></td> <td></td> <td></td> <td></td> </tr> <tr> <td>3-4</td> <td></td> <td></td> <td>X</td> <td></td> <td></td> <td></td> </tr> <tr> <td>5-6</td> <td></td> <td></td> <td></td> <td>X</td> <td></td> <td></td> </tr> <tr> <td>7-8</td> <td></td> <td></td> <td></td> <td></td> <td>X</td> <td></td> </tr> <tr> <td>9-10</td> <td></td> <td></td> <td></td> <td></td> <td></td> <td>X</td> </tr> </table> 	No. of contacts	0	1	2	3	4	5	1-2		X					3-4			X				5-6				X			7-8					X		9-10						X		16 A	1-polig / 5 kontakter		227623
No. of contacts	0	1	2	3	4	5																																									
1-2		X																																													
3-4			X																																												
5-6				X																																											
7-8					X																																										
9-10						X																																									
		25 A	1-polig / 5 kontakter		227629																																										

Voltmeteromkopplare med 0-läge

För mätning mellan faser, samt faser mot nolla.

Kontaktfunktion (x = kontakt sluten)	Anslutningar/ byglingar	Märkström (AC21)	Kontakter	Skylt	Best.nr.
---	----------------------------	---------------------	-----------	-------	----------



No. of contacts	L1	L2	L1	0	L1	L2	L3
1-2	X	X	X	X	X	X	X
3-4							
5-6		X	X		X	X	X
7-8							
9-10	X	X					X
11-12							

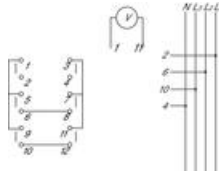

16 A

6 kontakter

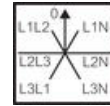

227636

Amperemeteromkopplare med 0-läge

För mätning mellan faser, samt faser mot nolla.



Kontaktfunktion
(x = kontakt sluten)

Anslutningar/
byglingar

Märkström
(AC21)

Kontakter

Skylt

Best.nr.

No. of contacts	0	L1	L2	L3
1-2	X	X		
3-4	X	X		
5-6		X	X	
7-8		X	X	
9-10	X		X	X
11-12			X	X

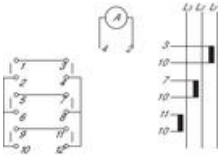

16 A

6 kontakter

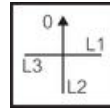

227637

TEKNISK DATA

Anslutning	Skruvanslutning
Antal kontakter	1
Antal poler	1
Antal positioner	2
Funktion	Kvarstående
IP-klass bakom panelen (vid blocken)	IP20
IP-klass, panel	IP40
Isolationsmärkspänning (Ui)	690 V
Kabelarea enkelledare max	4 mm ²
Kabelarea mångledare max	2,5 mm ²
Livslängd mekanisk	800 000 operationer (max. 150/tim.)
Modell	ON-OFF Brytare
Märkeffekt (AC23A/3x230 V)	4 kW
Märkeffekt (AC23A/3x400 V)	7,5 kW
Märkeffekt (AC3/3x230 V)	3 kW
Märkeffekt (AC3A/3x400 V)	4 kW
Märkström Ie (AC15/230 V)	6 A
Märkström Ie (AC21A/22A)	16 A
Skylt	48x48 mm

Standarder	CB, CCC, CE, CSA, IEC 60947-3 , IEC 60947-1, UL, UL 508
Temperaturområde från	-20 °C
Temperaturområde till	70 °C
Termisk ström Ith	20 A
Vinkel	45°

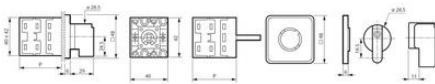
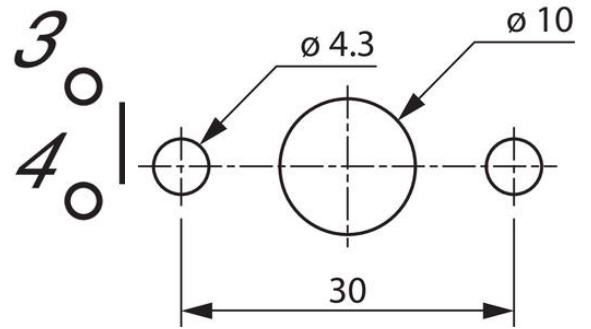
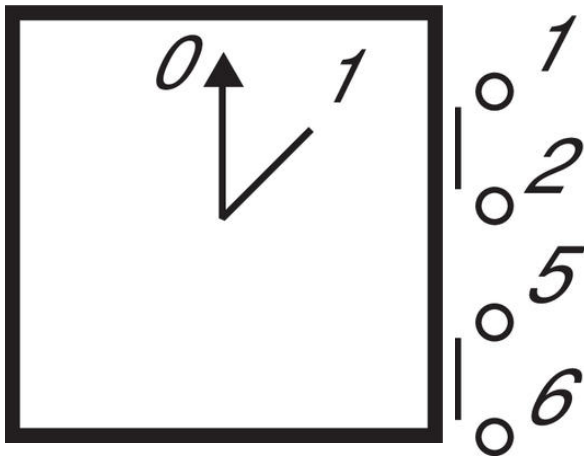

No. of contacts	0	1	
1-2		X	1P
3-4		X	2P
5-6		X	3P